



# Ginger

## Joan Gaspar

marset



**Ginger 60**

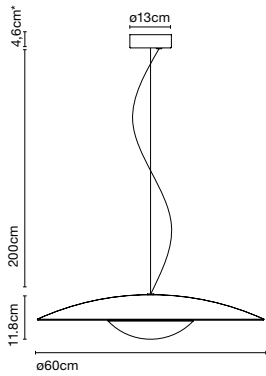

\* 6,5cm (DALI)

**Ginger 42**

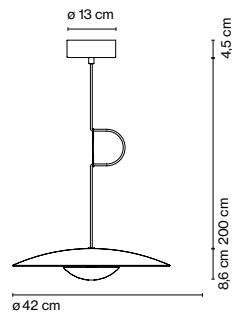

**Ginger 32**

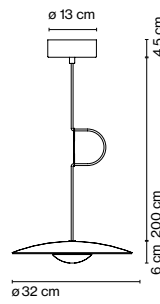

Wood is a great ally of cozy lighting. It is a material that is hard to mold, a challenge that the Ginger collection neatly resolves. The combination of sheets of wood and paper pressed together under high pressure achieves a laminate that appears almost entirely flat.

**Ginger 60**

LED SMD 28,5W 700mA  
2700K CRI90  
Luminaire 1165lm  
Lamp source 3023lm (included)

**Pressed wood or brushed aluminum diffuser. Injected and lacquered black metal matte aluminum dissipater.**

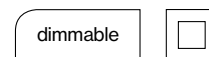

**Ginger 42**

LED SMD 21,7W 700mA  
2700K CRI90  
Luminaire 698lm  
Lamp source 2130lm (included)

- [Download](#) Assembly Instructions
- [Download](#) Photometric Data
- [Download](#) 2D
- [Download](#) 3D
- [Download](#) Energy label

**Ginger 32**

LED SMD 11,5W 700mA  
2700K CRI90  
Luminaire 350lm  
Lamp source 1066lm (included)

- Oak
- Wenge
- Brushed brass - Brushed brass
- Brushed brass - White
- Black - White
- White - White

Black electrical cord

Recessed canopy available

**Range**

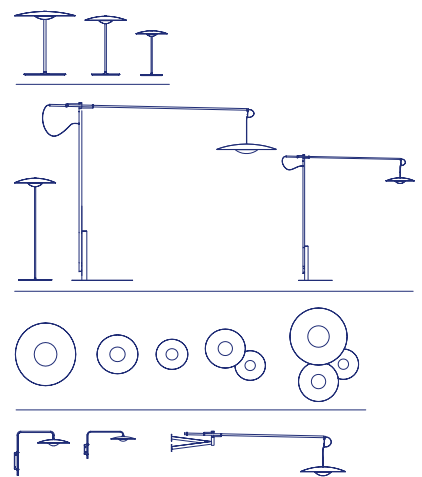

**Watch the video** [info@marset.com](mailto:info@marset.com)  
[www.marset.com](http://www.marset.com)



**Ginger 20**

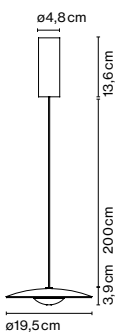

**Ginger 20x3**

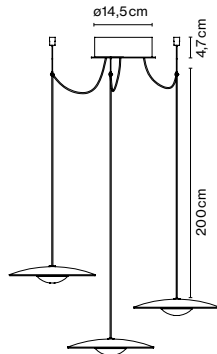

**Ginger 20x3:  
Canopy accessory**

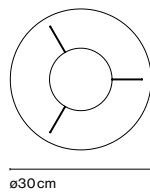

**Ginger 20**

LED SMD 6W 350mA  
2700K CRI90  
Luminaire 139lm  
Lamp source 546lm  
(included)

**Ginger 20x3**

3x LED SMD 6W 350mA  
2700K CRI90  
Luminaire 3x139lm  
Lamp source 3x546lm  
(included)

- Oak - Oak
- Wenge - Wenge
- Oak - White
- Wenge - White
- Brushed brass - Brushed brass
- Brushed brass - White
- Black - White
- White - White

Black electrical cord

Pressed wood or brushed aluminum diffuser.  
Injected and lacquered black metal matte aluminum dissipater.

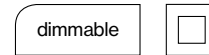

- [Download](#) Assembly Instructions
- [Download](#) Photometric Data
- [Download](#) 2D
- [Download](#) 3D
- [Download](#) Energy label

**Range**

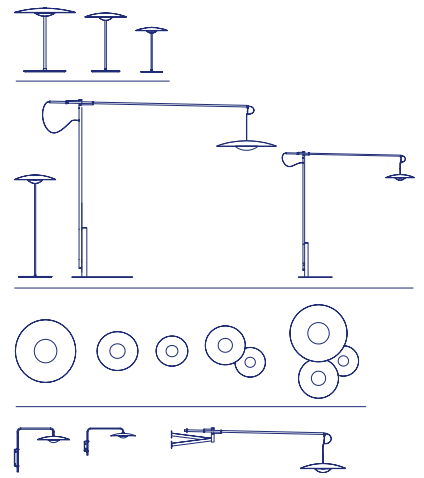

**Watch the video**

info@marset.com  
www.marset.com

Wood is a great ally of cozy lighting. It is a material that is hard to mold, a challenge that the Ginger collection neatly resolves. The combination of sheets of wood and paper pressed together under high pressure achieves a laminate that appears almost entirely flat.

**For mounted canopy installation**

Take into account the total power in watts, the power of the driver, and the wire entry points of the canopy. The total wattage of the selected lamps elements cannot exceed the max wattage of the canopy's driver. Therefore, you must choose your canopy/driver by the power required. Finally, the number of lamps installed in a single canopy cannot exceed the number of wire entry points of that canopy.

**Canopy 20W/ Circular**

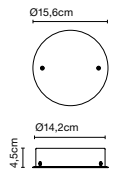

**Canopy 50W/ Circular**

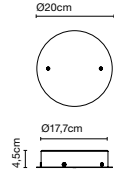

**Canopy 50W/ Rectangular**

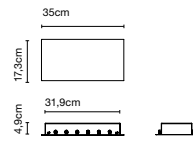

**Canopy 50W/ Circular**

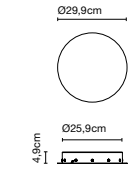

**Canopy 100W/ Circular**

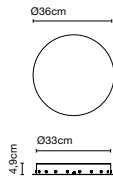

**Hook accessory**

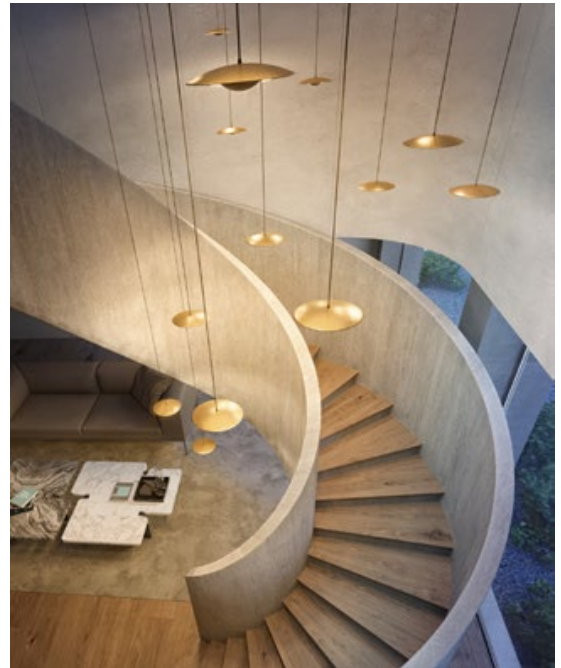

**Ginger 20 - 24V**

LED SMD 5,2W 24V 2700K CRI90

Lamp source - 480lm

(included)

**Wire entry points**

Canopy 20W/ Circular	3
Canopy 50W/ Circular	5
Canopy 50W/ Rectangular	9
Canopy 50W/ Circular	9
Canopy 100W/ Circular	19

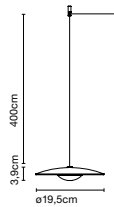

Black electrical cord

This system makes it possible to connect several suspension lamps into a single point of light, offering the absolute freedom to build with light. The Cluster accessory helps to illuminate large spaces or create compositions with the Dipping Light collection or the Ginger 20 model.

### How Ginger illuminates

