

Smart Kup 82 IP LED Warm Dim GE

124740XX_124741XX_124742XX

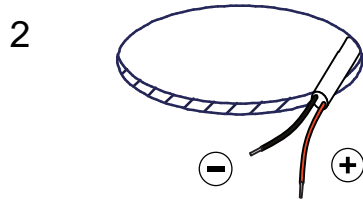

350mA - min 31Vf - max 36Vf - 12W

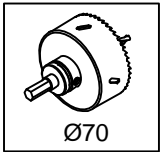
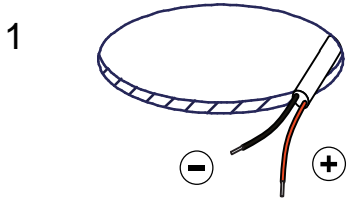
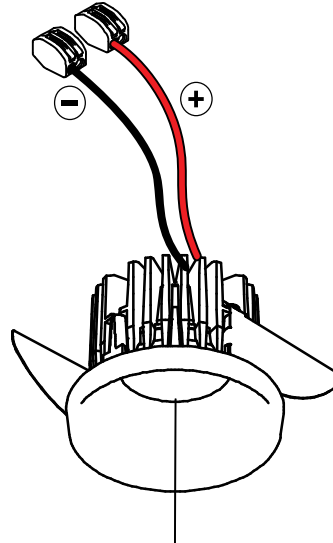

Replace protective shield when broken.
The luminaire shall only be used complete with its protective shield.
Reference number: 1010754

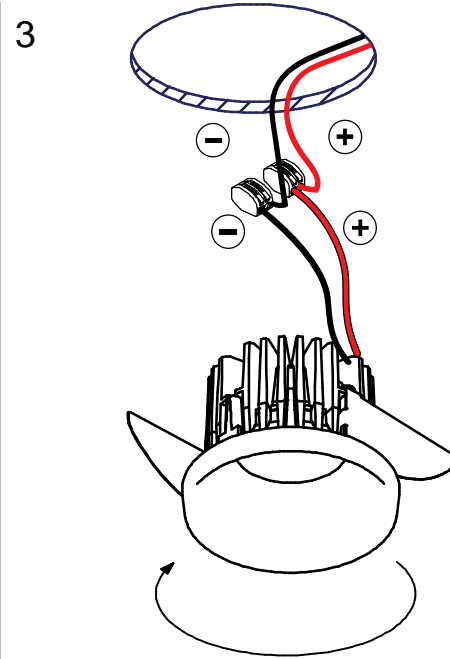
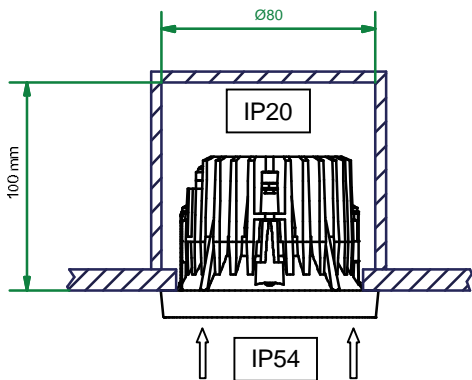

install : Twist clockwise
uninstall : Twist counterclockwise

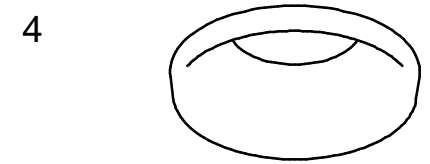

The light source contained in this luminaire shall only be replaced by the manufacturer or his service agent or a similar qualified person

CAN BE USED WITH

Drivers:
see driver matrix - latest version on website
www.supermodular.com or check sales contact

Recessed ring:
12500230 Recessed ring Ø70 H100

Surface box:
125160XX Smart SBS 82 GE for LED
125161XX Smart SBD 82 GE for 2xLED

Surface tubed:
128401xx Surface tubed long 1x GE
128410xx Surface tubed short 1x GE

Gypkit - conbox
12290130 Gypkit 190X190X Ø70
10889830 Conbox outer dim. 190x192x130

Mask:
12500009 Smart Mask 82 1x WhStr
12500032 Smart Mask 82 1x BlStr
12500046 Smart Mask 82 1x Gold
12500109 Smart Mask 82 2Lx WhStr
12500132 Smart Mask 82 2Lx BlStr
12500146 Smart Mask 82 2Lx Gold

